

127/PL 500F



FIXED BOLLARDS WITH COUNTERFRAME

The fixed 127/PL 500F PILOMAT have been designed and built with architectural appearance similar to that of the retractable PILOMAT bollards and therefore also allows the combined use of both versions.

Current models are the result of our 40 years' experience in the security field and in excess of 20 years in the specific design and manufacture of bollards.

GENERAL FEATURES

The fixed PILOMAT bollards are used in public or private areas in order to define or prevent the parking of vehicles, for preventing access to vehicles in pedestrian areas. These items, with a counterframe to wall, in addition to the architectural appearance of the automatic PILOMAT, allow the removal of the bollard in the event of such a removal being needed, or if impact has occurred.



PAG.1/2

PILOMAT

100% MADE IN ITALY



PILOMAT s.r.l.
www.pilomat.com / pilomat@pilomat.com
Via Zanica 17/p, 24050, Grassobbio (BG) Italy
Tel. +39.035.29.72.20
Copyright 2016© Pilomat S.r.l. All rights reserved

127/PL 500F_DATASHEET.16 REVIEW 16/11/2016

127/PL 500F



AVAILABLE ITEMS

PILOMAT BOLLARD 127/PL 500FEV - NORMAL STEEL PAINTED

PILOMAT BOLLARD 127/PL 500FIXV - STAINLESS STEEL PAINTED

PILOMAT BOLLARD 127/PL 500FIXS - STAINLESS STEEL BRUSHED

HEAD WITHOUT LOGO FOR PILOMAT 127/PL 500F

REFLECTING ADHESIVE STRIP - WHITE (NO-LOGO)

PAINTING WITH RAL COLOUR ON REQUEST

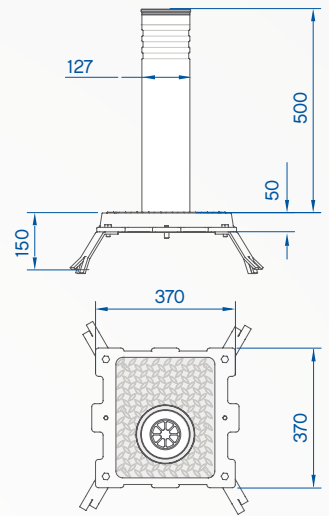

FIXED CYLINDER	NORMAL STEEL FE370 - AISI 304 STAINLESS STEEL
FIXED CYLINDER DIAMETER	127mm
FIXED CYLINDER HEIGHT	500mm
FIXED CYLINDER NORMAL STEEL THICKNESS	6mm
FIXED CYLINDER STAINLESS STEEL THICKNESS	6mm
FIXED CYLINDER NORMAL STEEL FINISH	ANTI-CORROSION TREATMENT - STANDARD PAINTING GREY ANTHRACITE
FIXED CYLINDER STAINLESS STEEL FINISH	AS ABOVE OR BRUSHED
REFLECTING ADHESIVE STRIP	YES - HEIGHT 23mm
PROTECTION CLASS	IP67
IMPACT RESISTANCE (WITHOUT DEFORMATION)	30.000 J
BREAKOUT RESISTANCE	150.000 J
BRACKETS INCLUDED	YES - 4 BRACKETS

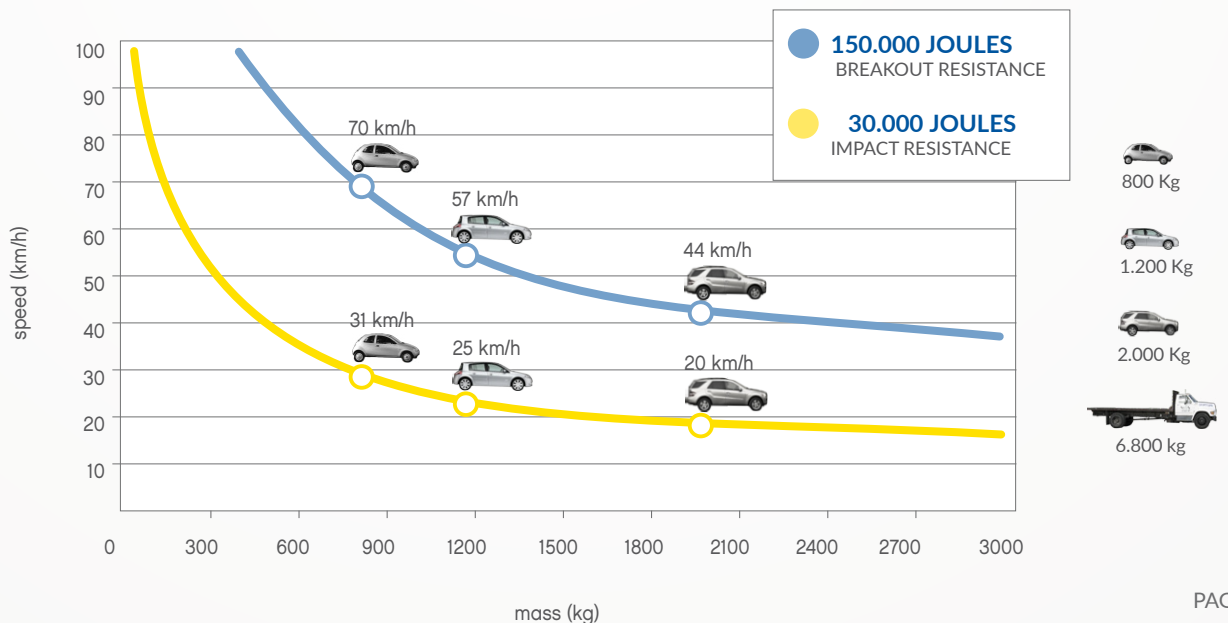

PILOMAT s.r.l.
 www.pilomat.com / pilomat@pilomat.com
 Via Zanica 17/p, 24050, Grassobbio (BG) Italy
 Tel. +39.035.29.72.20
 Copyright 2016© Pilomat S.r.l. All rights reserved

127/PL 500F_DATASHEET.16 REVIEW 16/11/2016